

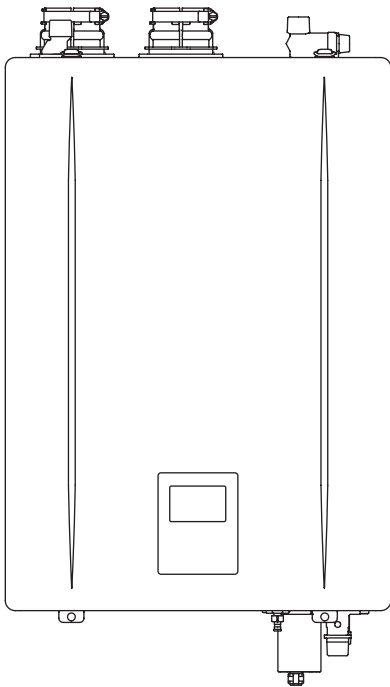

Owner's Guide

CONDENSING TANKLESS GAS WATER HEATER

Models: **EZ111DV** (GQ-C3261WX-FF-1 US) **NRCR111DV** (GQ-C3261WXQ-FF-1 US)
EZ98DV (GQ-C2861WX-FF-1 US) **NRCR92DV** (GQ-C2661WXQ-FF-1 US)
EZ71DV (GQ-C2661WX-FF-1 US)



(Example of EZ111DV (GQ-C3261WX-FF-1 US))

Thank you for purchasing this Noritz tankless gas water heater. Before using:

- Read this manual completely for operation instructions.
- (When a remote controller (RC-9018M) is installed) Please also read the information on how to operate the remote controller provided in the remote controller user's manual.
- To ensure full coverage by the Noritz America Limited Warranty service, see the warranty registration information (see page 36), and then visit the Noritz website (www.noritz.com/warranty) to register your product.
- Keep this manual where it can be found whenever necessary because the warranty registration information is included. (See page 36)

Installation must conform with local codes, or in the absence of local codes, the National Fuel Gas Code, ANSI Z223.1 / NFPA 54 (latest edition) and/or the Natural Gas and Propane Installation Code CSA B149.1 (latest edition).

When applicable, installation must conform with the Manufactured Home Construction and Safety Standard, Title 24 CFR, Part 3280 or the Canadian Standard CAN/CSA-Z240 MH Mobile Homes, Series M86.

Noritz America reserves the right to discontinue, or change at any time, the designs and/or specifications of its products without notice.

FOR USE IN RESIDENTIAL OR MANUFACTURED HOME APPLICATIONS.

⚠ WARNING If the information in this manual is not followed exactly, a fire or explosion can result causing property damage, personal injury, or loss of life.

<ul style="list-style-type: none"> • Do not store or use gasoline or other flammable vapors and liquids in the vicinity of this or any other appliance. 	<ul style="list-style-type: none"> • WHAT TO DO IF YOU SMELL GAS <ul style="list-style-type: none"> - Do not try to light any appliance. - Do not touch any electrical switch; do not use any phone in your building. - Immediately call your gas supplier from a neighbor's phone. Follow the gas supplier's instructions. - If you cannot reach your gas supplier, call the fire department. 	<ul style="list-style-type: none"> • Installation and service must be performed by a qualified installer, service agency or the gas supplier.
--	---	--

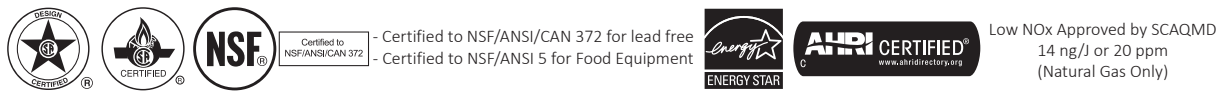

Important Safety Information

To prevent damage to property and injury to the user, the icons shown below will be used to warn of varying levels of danger.

Every indication is critical to the safe operation of the water heater and must be understood and observed.

Potential dangers from accidents during installation and use are divided into the following four categories. Closely observe these warnings; they are critical to your safety.

Icons warning of risk level



This is the safety alert symbol. This symbol alerts you to potential hazards that can kill or hurt you and others. Obey all safety messages that follow this symbol to avoid injury or death.

⚠ DANGER

Indicates an imminently hazardous situation that, if not avoided, will result in death or serious injury.

⚠ WARNING

Indicates a potentially hazardous situation that, if not avoided, could result in death or serious injury.

⚠ CAUTION

Indicates a potentially hazardous situation that, if not avoided, may result in minor or moderate injury.

NOTICE

Indicates a potentially hazardous situation that, if not avoided, may result in property damage.

⚠ DANGER

After the water heater has been out of use for a long time make sure that you fill the condensate trap with water.

This is to prevent dangerous exhaust gases from entering the building.

Failure to fill the condensate trap could result in severe personal injury or death.

(Refer to page 25 for further instructions.)

⚠ DANGER

Vapors from flammable liquids will explode and catch fire causing death or severe burns.

Do not use or store flammable products such as gasoline, solvents or adhesives in the same room or area near the water heater.



Keep flammable products:

- 1. Far away from the water heater.**
- 2. In approved containers.**
- 3. Tightly closed.**
- 4. Out of children's reach.**

Vapors:

- 1. Cannot be seen.**
- 2. Vapors are heavier than air.**
- 3. Go a long way on the floor.**
- 4. Can be carried from other rooms to the main burner by air currents.**

Hot water heater temperatures over 125°F (52°C) can cause severe burns instantly or death from scalding.

Children, disabled and elderly are at the highest risk of being scalded.

Feel water temperature before bathing or showering.

Temperature limiting valves are available, consult with installer.

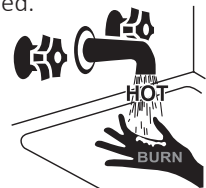

Do not use the water heater if the intake/exhaust pipe is displaced, has holes, is clogged or is corroded.

This will cause carbon monoxide poisoning and a potential fire hazard.

Do not allow anyone to change the water temperature while hot water is being used.

To prevent scalding, do not change the water temperature to a higher setting.

[When supplying combustion air from the indoors]

Check whether or not the air supply vent is blocked with dust, trash, a towel, or the like.

Blocking the opening may result in incomplete combustion.

⚠ WARNING

- A. This water heater does not have a pilot. It is equipped with an ignition device that automatically lights the burner. Do not try to light the burner by hand.
- B. BEFORE OPERATING smell all around the water heater area for evidence of leaking gas. Be sure to smell next to the floor because some gas is heavier than air and will settle on the floor.

WHAT TO DO IF YOU SMELL GAS

- Do not try to light any appliance.
 - Do not touch any electrical switch; do not use any phone in your building.
 - Immediately call your gas supplier from a neighbor's phone. Follow the gas supplier's instructions.
 - If you cannot reach your gas supplier, call the fire department.
- C. Use only your hand to turn the gas valve knob. Never use tools. If the knob will not turn by hand, don't try to repair it. Call a qualified service technician. Force or attempted repair may result in a fire or explosion.
- D. Do not use this water heater if any part has been under water. Immediately call a qualified service technician to inspect the water heater and to replace any damaged parts.

When a gas leak is noticed:

1. Stop use immediately.
2. Close the gas valve.

[Indoor Installation]

3. Open windows and doors.

If you detect abnormal combustion or abnormal odors, or during an earthquake, tornado or fire:

1. Turn off the hot water supply.
2. Turn off the power to the water heater.
3. Turn off gas and water supply valves.
4. Call the nearest Noritz agent.

Explosion Hazard;

If the temperature and pressure relief valve is dripping or leaking, have a qualified service technician replace it. Do not plug or remove the valve.

Failure to follow these instructions can result in fire or explosion, and personal injury, or loss of life.

Check the temperature of the running hot water before entering the shower.

Check the temperature before stepping into the bathtub.

To prevent burns or scalding, turn the water heater power off using the operation panel, app, or remote controller, and wait until the unit cools before performing maintenance.

Do not place the exhaust vent terminal in an indoor environment by means of adding walls and ceiling (Do not enclose using corrugated sheets, etc.).

Carbon monoxide poisoning or fire may occur as a result.

Leave the proper clearance between the water heater and nearby objects (trees, timber, boxes with flammable materials, etc.).

[Indoor Installation]

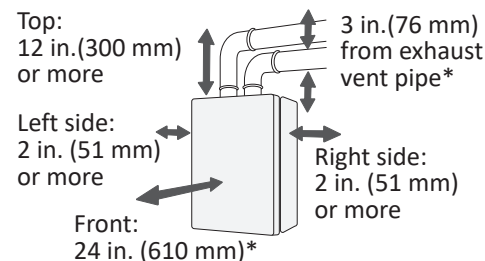

[Outdoor Installation]

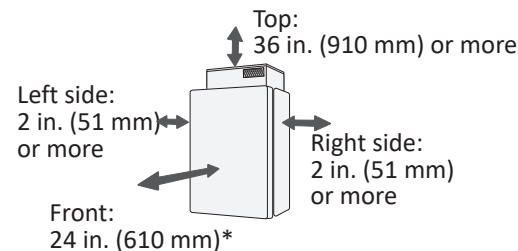

*Indicates suggested clearances for maintenance.

Do not place combustibles such as laundry, newspapers, oils etc. near the heater or the exhaust vent terminal.

Do not install this water heater in a recreational vehicle or on a boat as this may be a carbon monoxide poisoning hazard. Do not install this water heater in a mobile home when using SV conversion kit ("-SV" configuration).

Do not use combustible chemicals such as oil, gasoline, benzene etc. in the near the heater or the exhaust vent terminal.

Do not store or use gasoline or other flammable vapors and liquids in the vicinity of this or any other appliance.

Do not place or use a spray can near the water heater or the exhaust vent terminal.

⚠ WARNING

Be sure the water heater specifications and precautions on the rating plate.

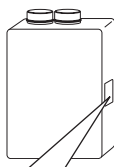

(Example of EZ111DV
(GQ-C3261WX-FF-1 US))

Model (Modèle) :	EZ111DV(GQ-C3261WX-FF-1 US)
Type of Gas (Type de gaz) :	Natural Gas (Gaz Naturel)
Input Rating (Débit calorifique) :	Max. 199,900 Btu/h - Min. 12,800 Btu/h
Recovery Rating (Capacité de recouvrement) :	237 Gal/h (897 l/h)
Inlet Gas Pressure (Pression de gaz d'entrée) :	Min. 3.5 "W.C. - Max. 10.5 "W.C.

When you use LP gas, check to see if the gas conversion sticker is attached to the unit.

Installation and service must be performed by a qualified installer, service agency or the gas supplier.

Consult the nearest Noritz agent if the water heater location needs to be changed.

If this unit will be installed in a location where hair spray or aerosols will be used, locate the unit in a separate area that is supplied with fresh air from outdoors.

Do not use hair spray or spray detergent in the vicinity of the unit.

Avoid installation in places where dust or debris will accumulate.
Dust may accumulate and reduce the performance of the fan.
This can result in incomplete combustion.

If the water heater is installed in a publicly accessible area (e.g. outdoors), lock the operation panel to prevent unauthorized access. (See page 9)

[When supplying combustion air from the indoors]

Check the air supply opening for dust or obstructions.

To prevent injury or death, do not allow small children to bathe or play in the bathroom unsupervised.

Do not touch the power cord with wet hands.



Contact a qualified service technician for any necessary repairs, service or maintenance.

Do not use parts other than those specified for this unit.

California Proposition 65 lists chemical substances known to the state to cause cancer, birth defects, death, serious illness or other reproductive harm. This product may contain such substances, be their origin from fuel combustion (gas, oil) or components of the product itself.

If a gas conversion is necessary, the conversion kit shall be installed by a qualified installer, service agency, or the gas supplier in accordance with the instructions and all applicable codes and requirements of the authority having jurisdiction. If the information in these instructions is not followed exactly, a fire, an explosion, or production of carbon monoxide can result causing property damage, personal injury, or loss of life. The qualified installer, service agency, or the gas supplier is responsible for the proper installation of this kit. The installation is not proper and complete until the operation of the converted unit is checked as specified in the instructions supplied with the kit.

⚠ CAUTION

Be sure to electrically ground the unit.

Keep power cord free of dust.

Do not use the water heater for other than hot water supply, shower and bath.

Do not use a broken or modified power cord.
Do not bind, bend or stretch power cords.
Do not scratch, modify, or subject them to impact or force.

Do not use condensate, discharged from the condensate drain pipe, for drinking or for consumption by animals.

If the unit is installed in a location with very high humidity, condensate may form inside the unit, which may cause incomplete combustion, damage to the electrical components, or electric leakage.

Do not turn off the water heater while someone is bathing.

⚠ CAUTION

Do not touch the exhaust vent pipe and exhaust vent terminal during or immediately after operation of the water heater.

Do not cover the water heater and the exhaust vent terminal, store trash or debris near it, or in any way block the flow of fresh air to the unit.

NOTICE

Do not drink water that has been inside the unit for an extended period of time. Do not drink the first use of hot water from the unit in the morning.

Clean the filter on the water inlet as frequently as required by the quality of your local water.

Keep the area around the water heater clean. If boxes, weeds, cobwebs, cockroaches etc. are in the vicinity of the unit, damage or fire can result.

Do not install the water heater where the exhaust will come into or contact with outer walls, other walls or materials that are not resistant to heat. Also consider trees and animals in the vicinity.

The heat and moisture from the water heater may cause discoloration of walls and resinous materials, or corrosion of aluminum materials.

If the water supply is in excess of 12 gpg (200 mg/L) of hardness, acidic or otherwise impure, treat the water with approved methods in order to ensure full warranty coverage. (See page 28)

Problems resulting from scale formation are not covered by the warranty.

Check ignition during use and extinction after use.

Do not run water through the unit when unit is not on.

When discharging hot water, make sure the unit is "on". If water is run through the unit with the unit "off", water may condense inside the unit and cause incomplete combustion or damage to the internal electrical components.

For single-handle fixtures, you'd turn the handle to the left.

This unit is configured for installations up to 1,000 ft above sea level without changes.

For installations above 1,000 ft above sea levels, contact Noritz America for Instructions.

(When a remote controller is installed)

Do not disassemble the remote controller.

Do not use chlorine-based, acidic, alkaline detergents, organic solvents such as benzene and thinner, or melamine sponge to clean the remote controller.

This may cause discoloration, deformation, scratches or cracks.

Do not splash water on the remote controller. Do not expose the remote controller to steam.

(For RC-7651M-B)

Although it is water resistant, too much water can cause damage.

(For RC-9018M)

It is not water resistant, water can cause damage.

Do not locate the remote controller near stoves or ovens.

This may cause damage or failure.

Contact Noritz before using with a solar pre-heater.

Preventing damage from freezing (See page 23)

- Damage can occur from frozen water within the unit and pipes even in warm environments. Be sure to read below for appropriate measures.
- Repairs for damage caused by freezing are not covered by the warranty.

Take necessary measures to prevent freezing of water and leakage of gas when leaving the unit unused for long periods of time. (See page 24)

If it is snowing, check the exhaust vent terminal for blockage.

Contents

Important Safety Information	2
Contents	6
About the Water Heater	6
About the Operation Panel	8
Part Names and Functions.....	8
Locking the Operation Panel.....	9
Initial Operation	9
Connecting the App to the Water Heater	10
How to Use EZ Start Plus®	12
Using the Water Heater	13
About the Recirculation	15
Configuring Settings and Performing Operations Using the Operation Panel ...	15
When the RC-7651M-B Remote Controller Is Installed	21
Part Names and Functions.....	21
Customizable Settings.....	21
Preventing Damage from Freezing	23
Regular Maintenance	26
Troubleshooting	28
Follow-up Service	32
Specifications	34
Warranty	36

About the Water Heater

This illustration shows an example of installation. The exact installation configuration may be slightly different.

1. Intake Pipe	7. Gas Supply Valve
2. Exhaust Pipe	8. Condensate Drain Pipe Discharge the condensate.
3. Pressure Relief Valve	9. Hot Water Return Valve
4. Hot Water Valve	
5. Water Supply Valve	
6. Operation Panel (See page 8)	

Indoor Installation

(Example of EZ models, direct vent installation)

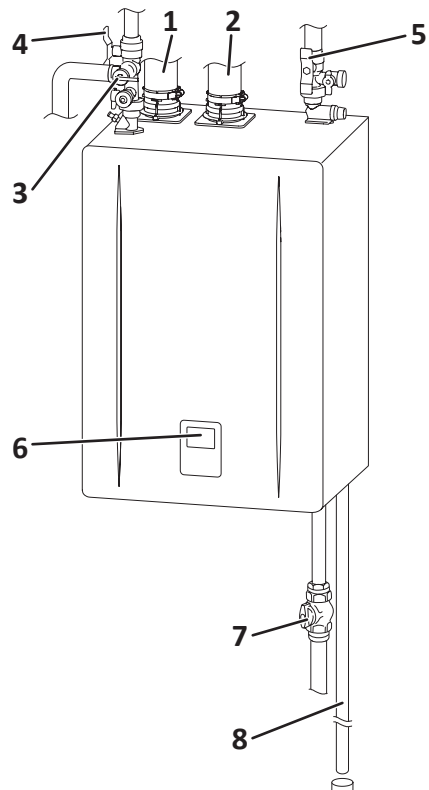

(Example of NRCR models, direct vent installation)

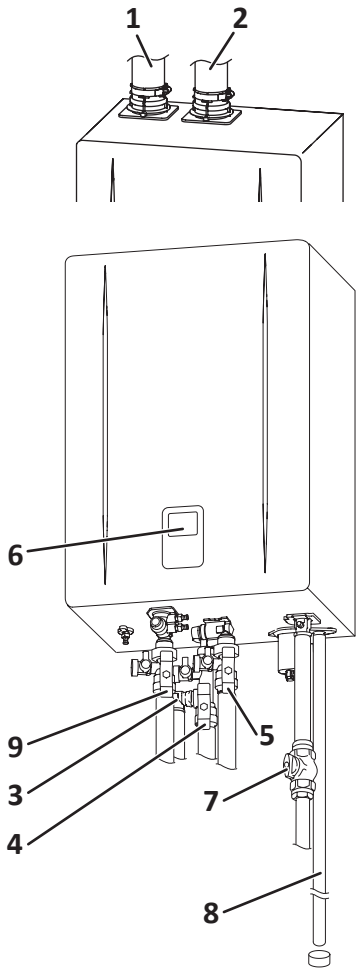

* The exterior view of air intake side ("Intake Pipe") may be different due to the installed item.

(Example of EZ models, non-direct vent installation)

Flex Vent 2 in. Conversion Kit (EZ2-CK-1)

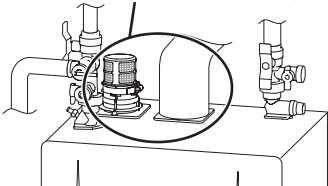

2 in. SV Conversion Kit (SV-CK-2-1)

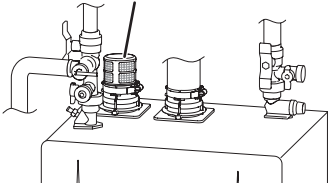

Outdoor Installation

(Example of EZ models)

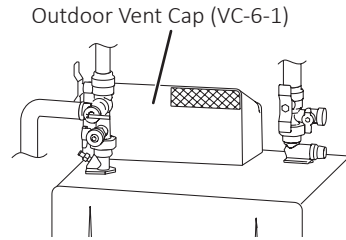

The condensing tankless gas water heater discharges condensate.

When heat from the exhaust gas is collected within the secondary heat exchanger, condensation occurs from moisture in the exhaust gas and the resulting water is discharged from the condensate drain pipe (approximately 2 gallons/h (7.5 L/h) maximum). It is not a water leak. Do not plug or block the drain line as it must always be allowed to freely flow.

Note : The condensate discharged is acidic with a pH level of approximately 2-3. A condensate neutralizer may be required by local code prior to disposal.

The condensing tankless gas water heater tends to emit white steam.

After the exhaust gas passes through the secondary heat exchanger, the low temperature and high moisture content tends to produce steam at the vent discharge terminal. This is a normal occurrence.



About the Operation Panel

Part Names and Functions

Buttons

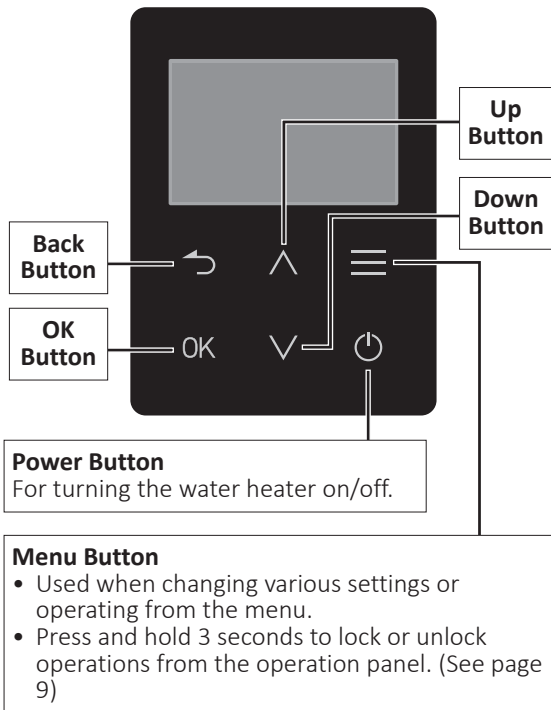

Display screen

- What is actually displayed depends on how the water heater is set.
- The backlight is blue during normal operation, but turns red when an error occurs.
- Sleep mode is available for reduced power consumption of the operation panel. The settings can be changed (refer to the “Configuring Settings and Performing Operations Using the Operation Panel: Settings”).
- When multiple units are installed, only one side’s operation panel can be operated.

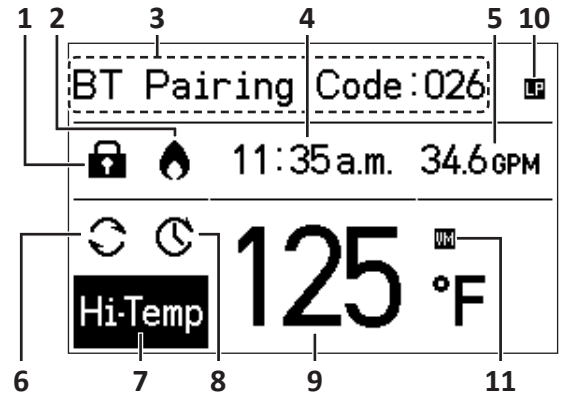

- 1. Locked**
Displayed while operation is locked.
- 2. Flame Symbol**
Displayed while the unit is actively heating.
- 3. Status**
Notifications concerning the unit such as error codes and freeze prevention operation are displayed.
- 4. Clock**
- 5. GPM**
The hot water flow rate is displayed.
- 6. Recirculation Operation**
Displayed during recirculation pump operation.
- 7. High Temperature Setting**
Displayed when the set temperature is 125°F (in °F mode) / 55°C (in °C mode) or higher.
- 8. Recirculation Timer**
Displayed when the timer is turned on with the Manual Timer or when Auto Learning is set. (See page 16)
- 9. Temperature Settings** (Example of 125°F)
The setting temperature displayed may vary from the actual temperature at the fixture depending on conditions such as season or length of piping.
- 10. Gas Type**
Displayed when LP gas is used.
- 11. Vacation Mode**
Displayed while the unit is set to vacation mode.

Locking the Operation Panel

⚠ WARNING

If the water heater is installed in a publicly accessible area (e.g. outdoors), lock the operation panel to prevent unauthorized access.

There are two ways to lock the operation panel:

- Locking automatically: Set “Screen Lock” to “Active” (see page 18). If no button on the operation panel is pressed for about 30 minutes, it will automatically lock.
- Locking manually: The following shows how to lock manually.

NOTE When the unit is installed outdoors, it is recommended to set “Screen Lock” to “Active” (see page 18) for safe operation of the unit.

Operation

Locking Manually / Unlocking

Press and hold the menu button for 3 seconds.

NOTE When set “Screen Lock” to “Active” (see page 18), the screen lock cannot be unlocked without entering the password, even if the unit is locked manually.

Initial Operation

Before the first use, do the following:

1. Open the water supply valve.

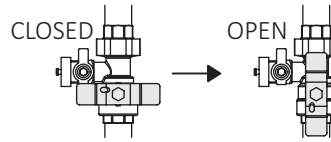

2. Open a hot water fixture/faucet to confirm that water is available, and then close the fixture/faucet again.

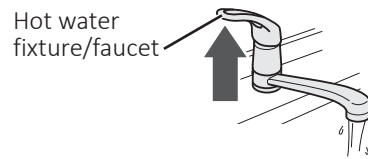

3. Open the gas supply valve.

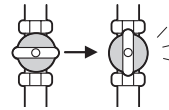

4. Connect the electrical power to the water heater.

⚠ WARNING

Do not touch the power cord with wet hands.

Connecting the App to the Water Heater

This unit has built-in Bluetooth®*. “EZ Start Plus®”, available on the iOS App Store or Google Play Store enhances functionality by allowing for: adjustment of the water heater temperature, adjustment of recirculation schedule, and more.

*Bluetooth®

The Bluetooth® word mark and logos are registered trademarks owned by Bluetooth SIG, Inc. and any use of such marks by NORITZ is under license. Other trademarks and trade names are those of their respective owners.

Canada Regulatory Information

This device complies with Innovation, Science and Economic Development Canada license-exempt RSS standards. Operation is subject to the following two conditions:

- 1) This device may not cause interference.
- 2) This device must accept any interference, including interference that may cause undesired operation of the device.

Le présent appareil est conforme aux CNR Innovation, Sciences et Développement économique Canada applicables aux appareils radio exempts de licence. L'exploitation est autorisée aux deux conditions suivantes :

- 1) l'appareil ne doit pas produire de brouillage;
- 2) l'utilisateur de l'appareil doit accepter tout brouillage radioélectrique subi, même si le brouillage est susceptible d'en compromettre le fonctionnement.

Contains IC: 4389B-EYSHCN
CAN ICES-003(B)/NBM-003(B)

FCC Regulatory Information

This device complies with Part 15 of the FCC Rules. Operation is subject to the following two conditions:

- 1) this device may not cause harmful interference, and
- 2) this device must accept any interference received, including interference that may cause undesired operation.

Contains FCC ID: RYYEYSHCN

⚠ CAUTION

Changes or modifications not expressly approved by the party responsible for compliance could void the user's authority to operate the equipment.

This equipment has been tested and found to comply with the limits for a Class B digital device,

pursuant to part 15 of the FCC Rules. These limits are designed to provide reasonable protection against harmful interference in a residential installation. This equipment generates, uses and can radiate radio frequency energy and, if not installed and used in accordance with the instructions, may cause harmful interference to radio communications. However, there is no guarantee that interference will not occur in a particular installation. If this equipment does cause harmful interference to radio or television reception, which can be determined by turning the equipment off and on, the user is encouraged to try to correct the interference by one or more of the following measures:

- Reorient or relocate the receiving antenna.
- Increase the separation between the equipment and receiver.
- Connect the equipment into an outlet on a circuit different from that to which the receiver is connected.
- Consult the dealer or an experienced radio/TV technician for help.

Trademarks

- EZ Start Plus is a trademark of Noritz Corporation.
- iPhone, iPad, and App Store are trademarks of Apple Inc.
- iOS is a trademark or registered trademark of Cisco in the U.S. and other countries and is used under license.
- Android is a trademark of Google LLC.
- Google Play and the Google Play logo are trademarks of Google LLC.

Setting Up a Bluetooth Connection on Your Smartphone

Compatible Smartphone OS Versions

- Operation is not guaranteed on all smartphone models.
- This compatibility information is accurate as of August, 2025. For the latest information, see the EZ Start Plus app information provided by the App Store® or Google Play™.

Android™

- OS 12.0 or later
- Resolution:

	Smartphone	Tablet
Min.	720 × 1,480	800 × 1,280
Max.	1,644 × 3,840	1,600 × 2,560

iPhone®/iPad®

- iOS 17.0 or later
- Resolution:

	Smartphone	Tablet
Min.	750 × 1,334	1,536 × 2,048
Max.	1,320 × 2,868	2,048 × 2,732

4. Please register your warranty. Tap "REGISTER".
 - When you have registered your warranty, close your browser.

NOTE Once you have closed the app and want to connect to the water heater again, wait for at least 30 seconds before reconnecting.

Downloading the App



Scan the two-dimensional barcode to download the app from the App Store or Google Play.

- Data charges may apply when you download or update the app.
- The service content, screen design, functions, etc. of the app are subject to change without prior notice.
- Changing the font size on your smartphone does not change the font size on the app.

Connecting via Bluetooth

NOTE When multiple water heaters exist, link all the water heaters and connect the electrical power before connecting to the app.

1. Start the EZ Start Plus app.
 - Move to a position within 3 ft (1 m) from the water heater.
2. Check "Others (e.g. Owner)" on the "Installer Authentication Setting" screen, and tap "NEXT".

NOTE This screen is only displayed the first time using the app.

3. Follow the instructions on the app.
 - Perform the following operations in order.
 - 1) Allow use of Bluetooth.
 - 2) Select the unit you wish to connect to.
 - 3) Locate the 3-digit code on the water heater operation panel.

NOTE

- When a dialog such as "Allow EZ Start Plus to" is displayed, select "Allow only while using the app", "Allow", etc.
- If a dialog prompting you to use Bluetooth or pair your device is displayed, allow.
- When connecting the same unit again, it is not necessary to enter the 3-digit number.
- (When multiple water heaters are installed) Select the unit whose name includes #1.

How to Use EZ Start Plus®

<p>Heater Information Allows you to view product information.</p> <p>FAQs Redirects you to the FAQ (Frequently Asked Questions) site.</p> <p>Contact Us Displays contact information.</p>	<p>Terms of Use Displays Terms of Use.</p> <p>Register Warranty Redirects you to the Register Warranty site.</p> <p>App Authentication Setting Enable to protect the app with a passcode. If you forget your passcode, you will need to reinstall the app.</p>	<p>Unit Operation History Displays app activity history.</p> <p>Installer Authentication Setting</p> <p>About Application</p>
--	---	--

Tap here to select the water heater to be operated when multiple water heaters are installed.

Tap and hold the  symbol and slide it to the desired temperature.

- If you do not tap "Set", the change you made will be canceled in a few seconds.
- When changing the temperature to 125°F (in °F mode) / 55°C (in °C mode) or higher, you need to change the "Maximum output temp. setting" in the "USER SETTING".

*1 *2 *3

Select the recirculation timer mode.

Auto Learning
(NRCR models only)

Manual Timer
The recirculation schedule can be set manually.

Timer Off

*1 *2

Display on/off schedule.

- Recirculation starts 15 minutes prior to the scheduled time so that hot water is available at the scheduled time.

*1 *2

Maximum output temperature setting

Drain Water
Prepares to drain water from the water heater. (See page 24)

Scale Flushing
Used to flush scales caused by hard water. (See page 28)

The app screen may vary by the app version.

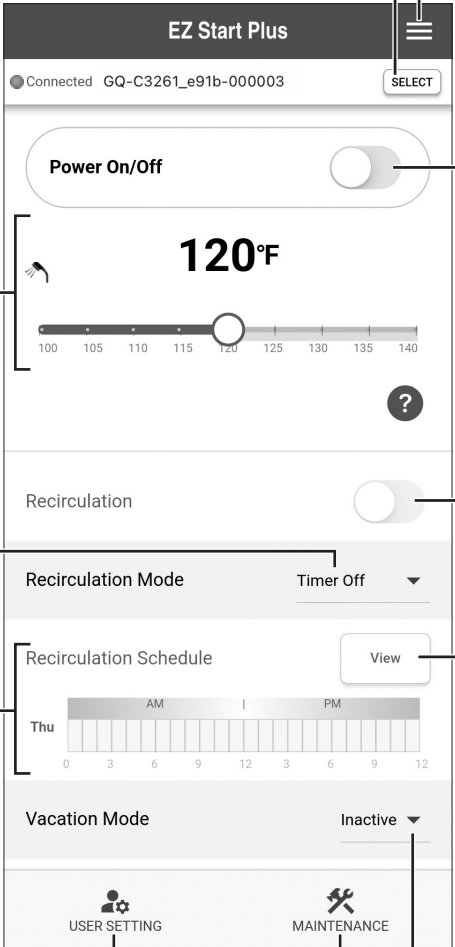

*4 *5

Turn the water heater operation on/off.

- Turning to "off", recirculation operation is also turned off.

*1 *2

- Turn the recirculation operation on/off. This switch can be turned on when the "Power On/Off" switch is "on".
- The "Recirculation" switch turns on or off corresponding to on or off in the "Recirculation Schedule". Even during a time window when recirculation is off in the schedule, turning the "Recirculation" switch "on" starts recirculation. Recirculation automatically turns off at the time set in the schedule.

*1 *2

View the recirculation schedule.
Can only be edited in Manual Timer mode.

- When "Auto Learning" is selected, changing it to "Manual Timer" allows you to edit the time windows. When you switch back to "Auto Learning" after editing, "Auto Learning" starts with the new time windows.

Use this setting when you want to suspend recirculation operation (e.g., when leaving for a vacation).

- *1: Displayed on NRCR models (except for when in on-demand mode) and EZ models that have an external recirculation pump installed.
- *2: When multiple water heaters are installed: Recirculation menu will only appear on the unit designated as #1. All operational settings will be set and controlled from this unit.
- *3: Auto Learning may not function properly when two crossover valves are used; therefore use Manual Timer.
- *4: This setting can be changed when the “Power On/Off” switch is turned off.
- *5: Used only for installation and maintenance.

To use a water heater with recirculation always on

Use the following settings.

- “Power On/Off” switch: On
- “Recirculation” switch: On
- “Recirculation Mode”: Timer Off

To use a water heater with recirculation always off

Use the following settings.

- “Power On/Off” switch: On
- “Recirculation” switch: Off
- “Recirculation Mode”: Timer Off

Using the Water Heater

Operation

1. Turn the water heater power on using the operation panel, app, or remote controller.
2. Check the set temperature using the operation panel, app, or remote controller.
3. Turn on hot water.

Changing the Hot Water Temperature

- Using the operation panel: Use the up or down button to set the temperature.
- Using the app: See page 12.
- Using the remote controller: Use the ▲ / ▼ buttons to set the temperature.

⚠ DANGER

- **To prevent scalding :**
Hot water heater temperatures over 125°F (52°C) can cause severe burns instantly or death from scalding.
- Children, disabled and elderly are at the highest risk of being scalded. Feel water temperature before bathing or showering. Temperature limiting valves are available, consult with installer.
- When the temperature is set to 125°F (in °F mode) / 55°C (in °C mode) or higher, the operation panel, app, and remote controller notify that the set temperature is high. With the operation panel and app, this notification is displayed on the screen. With the remote controller, the set temperature display flashes for 10 seconds and makes a notification sound.
- Take caution when using the water heater again after setting to 125°F (52°C) or higher. Always check the set temperature before use.
- Do not allow anyone to change the water temperature while hot water is running.

- NOTE**
- Hot water temperatures shown are approximate and may differ from the actual temperature at the fixture depending on external factors such as the season and length of piping in the system.

- When low temperatures are set, if the incoming water temperature is already quite high, it may be difficult to ensure the outgoing water temperature is as per the setting.
- When the hot water temperature is adjusted using thermostatic water mixing valves, set the temperature on the operation panel, app, or remote controller approximately 20°F (10°C) higher than the required temperature to ensure the appropriate fixture temperature.
- For most residential applications, the recommended setting temperature is 120°F (in °F mode) / 50°C (in °C mode) or less.
- (For NRCCR models using crossover valves)
The setting temperature can be set to only 120°F (in °F mode) / 50°C (in °C mode) or higher.

- NOTE**
- Consult local codes for minimum operating temperatures.
 - Noritz recommends that water temperature is set as low as possible to prevent scale build-up in the heat exchanger.

Temperature Setting Options

The temperature settings below are examples. The temperature setting necessary depends on the usage, the length of piping and the season.

When using °F mode (Default setting is 120°F)

Fahrenheit (°F)	100	105	110	115	120	125*	130*
	135*	140*					

*High temperature

The maximum output temperature can be set.

- Using the operation panel: Set in “Max Set Temperature” under “Settings” (see page 16).
- Using the app: Change in “USER SETTING”.
- Using the remote controller: See page 21.

When using °C mode (Default setting is 50°C (122°F))

Celsius (°C)	37	38	39	40	41	42	43
Fahrenheit (°F)	99	100	102	104	106	108	109

Celsius (°C)	44	45	46	47	48	50	55*
Fahrenheit (°F)	111	113	115	117	118	122	131

Celsius (°C)	60*
Fahrenheit (°F)	140

*High temperature

The maximum output temperature can be set.

- Using the operation panel: Set in “Max Set Temperature” under “Settings” (see page 16).
- Using the app: Change in “USER SETTING”.
- Using the remote controller: See page 21.

About the Recirculation

About “Auto-Recirculation” (NRCR models only)

- Use the following settings.
 - Using the operation panel: Set “Auto Learning” under “Recirc Mode” (refer to the “Configuring Settings and Performing Operations Using the Operation Panel: Recirc Mode”).
 - Using the app: Set “Recirc Mode” to “Auto Learning”.
- After the unit is installed, the auto scheduling function is activated once hot water has been used for at least 15 minutes.
- Once the auto scheduling function has been activated, recirculation turns on and off the next day at the same time hot water was used previously. After using the unit for a while, it automatically learns what times of the day hot water is used or not used and changes the weekly schedule accordingly.

If you want to suspend recirculation for a vacation or other reasons

- Using the operation panel: Set “Vacation Mode” to “Active” (see page 19).

NOTE Turning off the power button will stop both the hot water supply and the recirculation system.

- Using the app: Set “Vacation Mode” to “Active” (see page 12).

NOTE Setting the Power On/Off switch to “off” will stop both the hot water supply and the recirculation system.

If you want to suspend recirculation operation for a while, but want to use hot water

- Using the operation panel: Set “Always OFF” under “Recirc Mode” (refer to the “Configuring Settings and Performing Operations Using the Operation Panel: Recirc Mode”).
- Using the app: Select “Timer Off” for “Recirculation Mode” and turn off the “Recirculation” switch as well.
- Using the remote controller (RC-7651M-B): See page 22.

Configuring Settings and Performing Operations Using the Operation Panel

- Use the menu button to configure settings or perform operations.
- “Status” is displayed, but it is not available.

Recirculation

This setting is available for NRCR models (except for when in on-demand mode) and EZ models that have an external recirculation pump installed.

Recirc ON/OFF

- This can be set when the power button is on.
- This is a setting that manually starts or stops recirculation operation.
- **Default Setting** OFF

Operation

1. Press the menu button.
2. Use the up or down button to select “Recirculation”, then press the OK button.
3. Select “Recirc ON/OFF”, then press the OK button.
4. Select a value you want to set, then press the OK button.

ON/OFF

Recirc Mode

Default Setting Always OFF: Disabled
Always ON: Enabled
Manual Timer: Not set (-:--)
Auto Learning: Enabled

Operation

1. Press the menu button.

- Use the up or down button to select "Recirculation", then press the OK button.
- Select "Recirc Mode", then press the OK button.
- The steps after this vary depending on the purpose.

- **Always OFF**

Use the up or down button to select "Always OFF", then press the OK button.

- Set this when NOT USING recirculation or when NOT CONNECTING the pump control wire in the water heater.

- **Always ON**

Use the up or down button to select "Always ON", then press the OK button.

- Keeps hot water available 24/7, based on temperature only.
- (For EZ models) Connect the external recirculation pump to the pump control wire on the water heater.

- **Manual Timer**

- Operates the recirculation pump on a manually set schedule.
- (For EZ models) Connect the external recirculation pump to the pump control wire on the water heater.

How to Set or Add a Time Window

- Use the up or down button to select "Manual Timer", then press the OK button.
- Select "Timer Set", then press the OK button.
- Select "Add Time", then press the OK button.
- Set the start time, then press the OK button.
- Set the end time, then press the OK button.

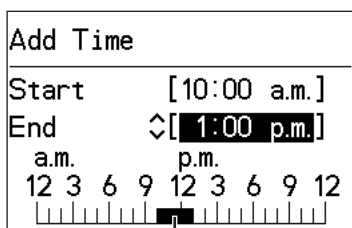

The set time window is displayed.

- Repeat step 4) and 5) to add another time window.

How to Reset All Time Windows

- Use the up or down button to select "Manual Timer", then press the OK button.
- Select "Timer Set", then press the OK button.
- Select "Reset All Time", then press the OK button.

How to Turn On or Off the Timer

- Use the up or down button to select "Manual Timer", then press the OK button.
 - Check the displayed set time window.

- Select "Timer ON/OFF", then press the OK button.
- Select a value you want to set, then press the OK button.

ON/OFF

- **Auto Learning**

Use the up or down button to select "Auto Learning", then press the OK button.

- The water heater automatically learns hot water usage patterns in a 24-hour period.
 - * The water heater learns daily usage patterns over a seven-day period.
- The current Auto Learning schedule can be viewed by accessing the "Manual Timer" screen.
- (For EZ models) "Auto Learning" is displayed, but it is not available with EZ models.

NOTE

- After switching from "Auto Learning" to "Manual Timer" using the operation panel and editing the schedule, the updated "Manual Timer" settings become active and the same schedule will be applied for 7 days. If you switch back to "Auto Learning" without editing, the previously learned 7-day schedule remains unchanged.
- When you edit the recirculation schedule using the remote controller (RC-9018M), the updated schedule will become active and the same schedule will be applied for 7 days.

Settings

Max Set Temperature

- This can be set when the power button is off.
- **Default Setting** 120°F (in °F mode) / 50°C (in °C mode)

Operation

- Press the menu button.
- Use the up or down button to select "Settings", then press the OK button.
- Select "Max Set Temperature", then press the OK button.

4. Select a value you want to set, then press the OK button.

[For Fahrenheit (°F)]
100- 140°F (in 5°F intervals)

[For Celsius (°C)]
37- 48°C (in 1°C intervals), 50- 60°C (in 5°C intervals)

Clock

- **Default Setting**
Time Format 12/24H: 12-hour display
Set Clock: 0:00 (24-hour display) or 12:00 a.m. (12-hour display)
Daylight Savings: Inactive
- The clock may be reset after a power outage or when the power is unplugged.

Operation

1. Press the menu button.
2. Use the up or down button to select “Settings”, then press the OK button.
3. Select “Clock”, then press the OK button.
4. The steps after this vary depending on the purpose.
 - **Time Format 12/24H** (Switching between 12-hour and 24-hour formats)
 - 1) Use the up or down button to select “Time Format 12/24H”, then press the OK button.
 - 2) Select a value you want to set, then press the OK button.

12-hour display / 24-hour display

- **Set Clock** (Setting the clock)
 - 1) Use the up or down button to select “Set Clock”, then press the OK button.
 - 2) Set the clock, then press the OK button.

Power Saving Dis.

- Selecting “OFF” will cause LCD (text) to be displayed at all times.
- **Default Setting** ON

Operation

1. Press the menu button.
2. Use the up or down button to select “Settings”, then press the OK button.

3. Select “Power Saving Dis.”, then press the OK button.
4. Read the displayed text, then press the OK button.
5. Select a value you want to set, then press the OK button.

ON/OFF

Brightness

Default Setting Normal

Operation

1. Press the menu button.
2. Use the up or down button to select “Settings”, then press the OK button.
3. Select “Brightness”, then press the OK button.
4. Select a value you want to set, then press the OK button.

Bright/Normal/Dim/Dark

Touch Sound

Default Setting ON

Operation

1. Press the menu button.
2. Use the up or down button to select “Settings”, then press the OK button.
3. Select “Touch Sound”, then press the OK button.
4. Select a value you want to set, then press the OK button.

ON/OFF

Backlight

- This can be set to increase the delay before the backlight turns off when the screen is in sleep mode.
- **Default Setting** Power Save ON

Operation

1. Press the menu button.
2. Use the up or down button to select "Settings", then press the OK button.
3. Select "Backlight", then press the OK button.
4. Select a value you want to set, then press the OK button.

Power Save ON / Power Save OFF

Audible Alarm

- This can be set to sound an alarm when an error occurs.
- The alarm sound will stop in the following cases:
 - 60 minutes after the error occurs
 - When a button is pressed
- **Default Setting** ON

Operation

1. Press the menu button.
2. Use the up or down button to select "Settings", then press the OK button.
3. Select "Audible Alarm", then press the OK button.
4. Select a value you want to set, then press the OK button.

ON/OFF

Contrast

Default Setting Standard

Operation

1. Press the menu button.
2. Use the up or down button to select "Settings", then press the OK button.
3. Select "Contrast", then press the OK button.
4. Select a value you want to set, then press the OK button.

-15 / -14 / ... / -1 / Standard / +1 / ... / +14 / +15

Screen Lock

- It can be set so that the operation panel will automatically lock if no button is pressed for about 30 minutes, and the screen lock cannot be unlocked without entering the password.
 - * Make sure not to forget your lock screen password.
- When set to "Active", the screen lock cannot be unlocked without entering the password, even if the unit is locked manually.
- **Default Setting** Inactive

Operation

1. Press the menu button.
2. Use the up or down button to select "Settings", then press the OK button.
3. Select "Screen Lock", then press the OK button.
4. Select a value you want to set, then press the OK button.

Active/Inactive

5. When you select "Active", use the up or down button to set the password, then press the OK button.
Repeat this 4 times to set a 4-digit number.

Password Setting

↕ [0] [0] [0] [0]

[°F/gal/ft] [°C/L/m]

- It can be set within 10 minutes after connecting the electrical power to the water heater and while the power button is off.
- **Default Setting** [°F/gal/ft]

Operation

1. Press the menu button.
2. Use the up or down button to select "Settings", then press the OK button.
3. Select "[°F/gal/ft] [°C/L/m]", then press the OK button.
4. Select a value you want to set, then press the OK button.

[°F/gal/ft] / [°C/L/m]

Default Settings

- It can be set within 10 minutes after connecting the electrical power to the water heater and while the power button is off.
- Items other than “Screen Lock” in “Settings” are reset.

Operation

1. Press the menu button.
2. Use the up or down button to select “Settings”, then press the OK button.
3. Select “Default Settings”, then press the OK button.
4. Press and hold the OK button for about 5 seconds.

Vacation Mode

- Use this setting when you want to suspend recirculation operation (e.g., when leaving for a vacation).
- **Default Setting** Inactive

Operation

1. Press the menu button.
2. Use the up or down button to select “Vacation Mode”, then press the OK button.
3. Select a value you want to set, then press the OK button.

Active/Inactive

Drain Water

- This can be set when the power button is off.
- Use this setting when draining water from the unit (see page 24).
- **Default Setting** Cancel

Operation

1. Press the menu button.
2. Use the up or down button to select “Drain Water”, then press the OK button.
3. Select “Start”, then press the OK button.

Start/Cancel

Flow Meter Alarm

- This can be set when only one water heater is installed and its power button is on.
- The flow meter alarm is used to indicate when a tub is full.
- Hot water does not automatically stop.
- **Default Setting** Alarm OFF

Operation

1. Press the menu button.
2. Use the up or down button to select “Flow Meter Alarm”, then press the OK button.
3. Select a value you want to set, then press the OK button.

[For gallon]
10- 60 gal (in 5 gal intervals), 70- 100 gal (in 10 gal intervals), Alarm OFF

[For liter]
40- 240 L (in 20 L intervals), 260- 380 L (in 40 L intervals), Alarm OFF

Scale Flushing

- This can be set when the power button is off.
- This item is used when flushing the heat exchanger in the unit. Refer to the “Procedure for Flushing the Heat Exchanger” in the installation manual or contact Noritz America for more information. (<http://support.noritz.com/> or 1-866-766-7489)
- **Default Setting** Cancel

Operation

1. Press the menu button.
2. Use the up or down button to select “Scale Flushing”, then press the OK button.
3. Select “Start”, then press the OK button.

Start/Cancel

Maintenance Monitor

The maintenance monitor is used to check various unit data during servicing.

Operation

1. Press the menu button.
2. Use the up or down button to select “Maintenance Monitor”, then press the OK button.

Sys. Maint. Monitor

- The system maintenance monitor is used to check various data from multiple connected units during servicing.
- “Sys. Maint. Monitor” is displayed even when only one unit is installed, but this function is only active when multiple water heaters are installed.

Operation

1. Press the menu button.
2. Use the up or down button to select “Sys. Maint. Monitor”, then press the OK button.

Error History

Operation

1. Press the menu button.
2. Use the up or down button to select “Error History”, then press the OK button.

Error History	1/2
1 . [12-1]	1 days ago
2 . [73]	30 days ago
3 . [11]	3650 days ago
4 . [----]	---- days ago

Select an error and press the OK button to view the error details.

- The eight most recent failures related to the unit are displayed. “1” indicates the latest failure.

Heater Info.

The product/model name and serial number are displayed.

Operation

1. Press the menu button.
2. Use the up or down button to select “Heater Info.”, then press the OK button.
 - Use the up or down button to scroll through the pages.

When the RC-7651M-B Remote Controller Is Installed

Part Names and Functions

- What is actually displayed depends on how the water heater is set.
- Before use, remove the protective sheet from the remote controller surface.

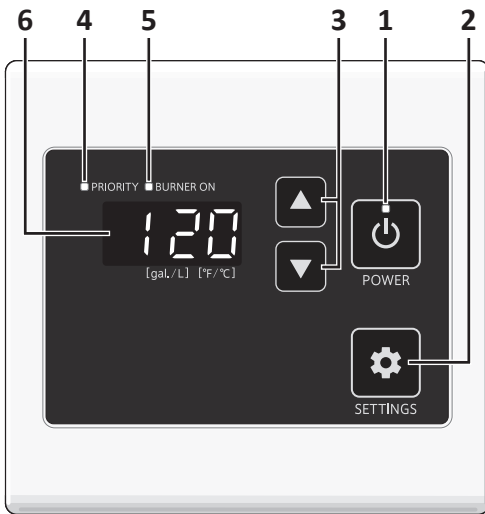

1. POWER Button / Indicator

- For turning the water heater on/off.
- The indicator blinks if a failure occurs.

2. SETTINGS Button

For setting the flow meter alarm, and other settings.

3. ▲/▼ Buttons

For setting the hot water temperature, the flow meter alarm, and other settings.

4. PRIORITY Indicator

- When this indicator is displayed, the hot water temperature can be set.
- The indicator blinks if a failure occurs.

5. BURNER ON Indicator

When burning, the indicator is displayed.

6. Temperature Setting (Example of 120°F)

- The setting temperature displayed may vary from the actual temperature at the fixture depending on conditions such as season or length of piping.
- When high temperature is set, blink for 10 second.

Flow Meter Setting (See page 22)

Error Code

A number blinks if a failure occurs. (See page 31)

NOTE As shipped from the factory, the remote controller is set to display in °F and gallon.
To adjust the display to °C and liters, refer to the installation manual.

Customizable Settings

Limiting the Maximum Output Temperature

The maximum output temperature can be limited to prevent discharging hot water at too high of a temperature.

Operation

1. The button is “off”.
2. Press and hold the button until a sound is heard (approximately 2 seconds).
3. Change the temperature using the ▲ / ▼ buttons. (Setting completed)

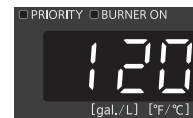

(Example of 120°F)

[For Fahrenheit (°F)]
100 - 140°F (in 5°F intervals)

[For Celsius (°C)]
37 - 48°C (in 1°C intervals), 50 - 60°C (in 5°C intervals)

(Default setting: 120°F/50°C)

- Set the button to “on” when continuing to use the water heater as is. Otherwise, let the water heater sit for approximately 30 seconds.

Muting the Remote Controller

The remote controller will emit a sound when any button is pressed. This sound can be muted if it is desired.

Operation

Press and hold the  button for 5 seconds.

[Muted] No sound after 5 seconds
[Sound] The sounds after 5 seconds







(Default setting: Sound)

- The flow meter alarm cannot be muted.
- The high temperature warning tone when setting the water heater to 125°F (in °F mode) / 55°C (in °C mode) or higher will not emit a sound when muted.

Flow Meter Alarm

The flow meter alarm is being used to indicate when a tub is full.

Operation

1. The  button is “on”.
 - Check the current setting temperature.
2. Set the temperature using the  /  buttons.
3. Press the  button, and adjust with the  /  buttons.
 - The flow meter setting will be blinking.

[For gallon] 10- 60 gal (in 5 gal intervals), 70- 100 gal (in 10 gal intervals), 990 gal
[For liter] 40- 240 L (in 20 L intervals), 260- 380 L (in 40 L intervals), 990 L

(Default setting: 990 gal (990 L))



- The alarm will not sound if it is set for 990 gal (990 L).
 - The level can only be adjusted while the flow meter setting is blinking.
 - After 10 seconds, the remote controller will again display the temperature.
4. Turn on hot water.
 - When the tub fills with the preset volume of water, an alarm will sound alerting you to shut off the water.

5. Turn off the hot water when the alarm sounds to prevent overflowing.

- NOTE**
- The hot water filling temperature is same as the setting temperature.
 - Although the temperature can be set to 125°F (in °F mode) / 55°C (in °C mode) or higher, do not set the temperature to 125°F (in °F mode) / 55°C (in °C mode) or higher as it can cause severe burns instantly or death from scalding.

Stopping Recirculation Operation (NRCR models only)

Operation

1. The  button is “off”.
2. Press and hold the  button until a sound is heard (approximately 2 seconds).
 - The maximum hot water temperature will blink.

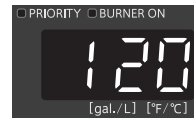

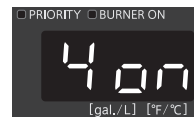

(Example of 120°F)

3. Press the  button several times until the item number “4” is displayed.



(Example of on)

4. Change the setting using the  /  buttons. (Setting completed.)

on: Recirculation on
oF: Recirculation off

(Default setting: on)

- Set the  button to “on” when continuing to use the water heater as is. Otherwise, let the water heater sit for approximately 30 seconds.

Preventing Damage from Freezing

NOTICE

- Damage can occur from frozen water within the unit and pipes even in warm environments. Be sure to read below for appropriate measures.
- Repairs for damage caused by freezing are not covered by the warranty.

The freeze prevention heater and pump (NRCR models only) on the unit automatically prevent the unit from freezing.

Freezing cannot be prevented when the power plug is unplugged. Do not disconnect the electrical power from the water heater.

Freezing will be prevented regardless of whether the POWER button / Power switch is “on” or “off”.

- In normal operation, freezing is prevented within the water heater automatically unless the outside temperature without wind is below -30°F (-35°C) when supplying combustion air from the outdoor (Direct Vent) or -4°F (-20°C) when the water heater is installed outdoors.
- For indoor installation, when supplying combustion air from the indoors, the room temperature must be greater than 32°F (0°C) to prevent freezing and the room inside must not have negative pressure.
- The freeze prevention heaters will not prevent the plumbing external to the water heater from freezing. Protect this plumbing with insulation, heat tape or electric heaters, solenoids, or pipe covers. If there remains a freezing risk, contact the nearest Noritz agent.

Take the measures below for extremely cold temperatures*.

* Outside temperature including wind chill factor less than -30°F (-35°C) when supplying combustion air from the outdoor (Direct Vent) or -4°F (-20°C) when the water heater is installed outdoors.

This method can protect not only the water heater, but also the water supply, water piping and mixing valves.

1. Turn off the POWER button / Power switch.
2. Close the gas supply valve.
3. Open a hot water fixture/faucet, and keep a small stream of hot water running. (0.1 gallons (400 mL)/minute or about 0.2 in. (4 mm) thick.)
 - If there is a mixing valve, set it to the highest level.
 - When linking multiple water heaters, discharge water equivalent to 0.1 gallons (400 mL)/minute per water heater.
4. The flow may become unstable from time to time. Check the flow 30 minutes later.
 - In general, it is not advisable to run water through the water heater when it is “off” (see page 5), but in this case freeze prevention is more important.

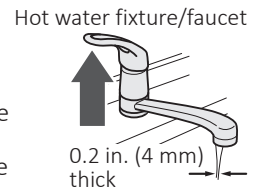

- NOTE**
- Remember to set mixing valves and fixtures to their original levels before using the water heater again to prevent scalding.
 - If there is still a risk that the water heater will freeze, drain the water heater as shown on “If the water heater will not be used for a long period of time, drain the water.”.

If water will not flow because it is frozen

1. Close the gas and water valves.
2. Turn off the POWER button / Power switch.
3. Open the water supply valve from time to time to check whether water is running.
4. When the water is flowing again, check for water leaks from the water heater and piping before using.

NOTE If the water heater or the piping is frozen, do not use the water heater or it may get damaged.

If the water heater will not be used for a long period of time, drain the water.

⚠ WARNING

- To prevent burns or scalding, turn the water heater power off using the operation panel, app, or remote controller, and wait until the unit cools before performing maintenance.
- Do not touch the power cord with wet hands.

- To prevent damage from freezing, the water heater must be plugged into power at all times. If power is unplugged, drain the water completely from the water heater. Then use an air compressor to remove all water from inside the water piping of the water heater.
- It is recommended that isolation valves are installed on the water heater, otherwise the water connections will need to be removed to drain the water heater completely.
- Freeze damage due to not draining properly will not be covered under warranty.
- Drain water into a bucket to prevent water damage.

Draining Water Using the Operation Panel, App, or Remote Controller

Using the operation panel

1. Turn off the power button.
2. Press the menu button.
3. Set "Drain Water" to "Start" (see page 19).





Proceed to steps 5-9

Using the app

1. Set the "Power On/Off" switch to "off".
2. Tap "User Setting".
3. Turn the "Drain Water" switch on.

Proceed to steps 5-9

Using the remote controller

1. The  button is "off".
2. Press and hold the  button until a sound is heard (approximately 2 seconds).
 - The maximum hot water temperature will blink.
3. Press the  button several times until the item number "5" is displayed.
4. Press the  button.
 - The display will change from "oF" to "on".



Proceed to steps 5-9

5. Close the water supply valve.

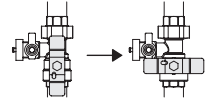

6. Fully open all hot water fixtures/faucets.

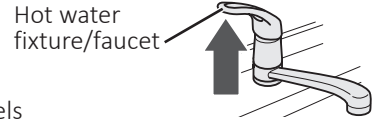

7. • For EZ models
Open all drain plugs and drain the water out of the water heater.

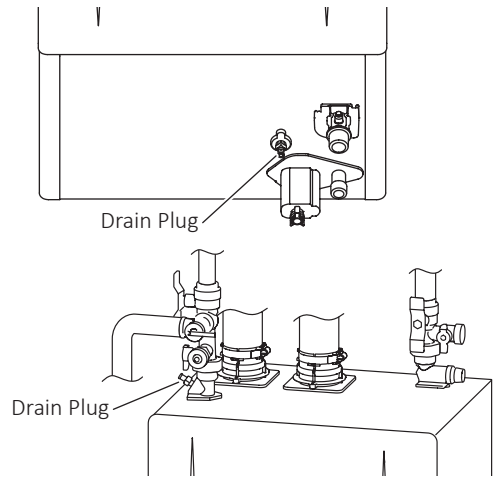

- Each drain plug might not be visible if insulation is installed around the piping.

- For NRCR models

- 1) Open drain plug (A) on the hot water side. Or open the port (a) and small valve (b) of isolation valve on hot water side.

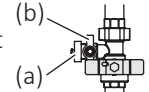

- 2) Open drain plug (with filter) (B) on the cold water side. Or open the port (a) and small valve (b) of isolation valve on cold water side.

- 3) Open other drain plugs (C, D, E) and wait until finish draining water.

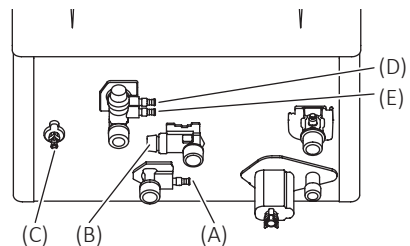

- Each drain plug might not be visible if insulation is installed around the piping.

8. When the water is completely drained, reattach all drain plugs and close the hot water fixtures/faucets.
9. Close the gas valve and disconnect the electrical power from the water heater.

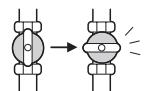

Do not touch with wet hands.

Manual Draining

1. Close the gas valve.

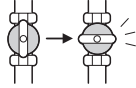

2. The POWER button / Power switch is "on".
3. Turn and leave open the hot water fixtures/faucets for more than 2 minutes and close.

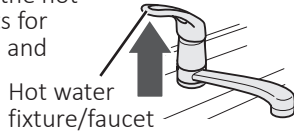

- If multiple water heaters are being used, drain 2 minutes for each water heater.
 - Error code "11" or "41" may appear on the operation panel. This is not a malfunction of the water heater. Do not turn the POWER button / Power switch off.
4. Close the water supply valve and disconnect the electrical power from the water heater.

Do not touch with wet hands.

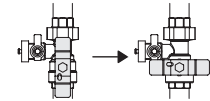

5. Fully open all hot water fixtures/faucets.
6. Perform steps 7 and 8 in "Draining Water Using the Operation Panel, App, or Remote Controller" (see page 24).

3. Open the water supply valve.
4. Open a hot water fixtures/faucets to confirm that water is available, and then close the hot water fixtures/faucets again.
5. Open the gas supply valve.
6. Connect the electrical power to the water heater.

Do not touch with wet hands.

7. Make sure that the area around the unit is well ventilated; open a window or a door if necessary. Then, operate the water heater and verify that condensate is coming out of the condensate drain pipe. (During normal use of the water heater, condensate will begin to discharge from the condensate drain pipe within 15 minutes of use. However, depending on the season and/or installation site conditions, it may take longer.)

NOTE If water does not appear at the end of the drain line, a qualified service technician must clean the condensate line.

Turning the Water Heater Back On

⚠ DANGER

After the water heater has been out of use for a long time, make sure that you fill the condensate trap with water.

This is to prevent dangerous exhaust gases from entering the building.

Failure to fill the condensate trap can result in severe personal injury, or loss of life.

(By performing below, the condensate trap will automatically fill itself with water.)

⚠ WARNING

Do not touch the power cord with wet hands.

1. Check that all drain plugs are inserted.
2. Check that all hot water fixtures/faucets are closed.

Regular Maintenance

Periodic Inspection

Periodic check and maintenance should be performed once a year by a qualified service technician to assure that all the equipment is operating safely and efficiently. We recommend to make necessary arrangements with a service contractor.

⚠ WARNING

To prevent burns or scalding, turn the water heater power off using the operation panel, app, or remote controller, and wait until the unit cools before performing maintenance.

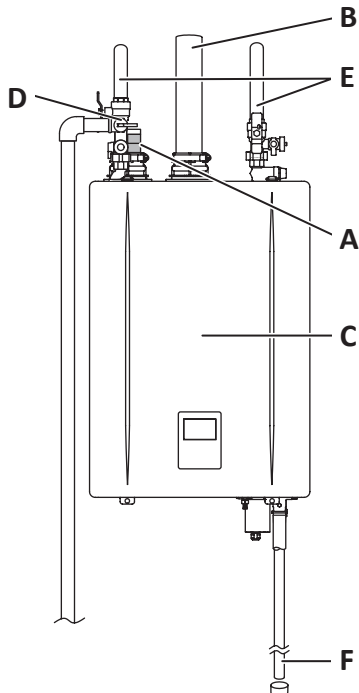

(Example of EZ models)

Check : A

[When supplying combustion air from the indoors]
For smear or blockage with dust, oil, etc. at the air supply vent.
If blocked, remove the build-up with a vacuum cleaner or damp towel.

NOTE Do not completely remove the inlet screen and the air screen.

Check : B

For dust and soot in the exhaust vent or the exhaust vent terminal.

Check : C

- For abnormal sounds during operation.
- For abnormalities in external appearance, discoloration or flaws.

Check : D

For proper operation of pressure relief valve.

Check : E

For water leaks from the water heater and piping.

Check : F

For blockage at the condensate drain pipe discharge.

Check

For laundry, newspaper, timber, oil, spray cans and other combustible materials near the water heater or the exhaust vent terminal.

Periodic Maintenance

Water Heater

Wipe the outside surface with a wet cloth, then dry the surface. Use a neutral detergent to clean any stains.

If an external condensate neutralizer is installed, periodic replacement of the neutralizing agent will be required. Refer to the instructions supplied with the neutralizer for suggested replacement intervals.

Operation Panel and Remote Controller

Wipe the surface with a wet cloth.

NOTE • Do not use chlorine-based, acidic, alkaline detergents, organic solvents such as benzene and thinner, or melamine sponge to clean the operation panel and remote controller; discoloration, deformation, scratches or cracks may occur.

- The remote controller is water resistant but not water proof. Keep it as dry as possible.

Water Drain Valve (with Water Filter)

If the water drain valve (with water filter) is covered with debris, the hot water may not run smoothly, or the water heater may put out cold water. Check and clean the filter as explained below.

⚠ WARNING

To prevent burns or scalding, turn the water heater power off using the operation panel, app, or remote controller, and wait until the unit cools before draining the water.

1. Close the hot water valve and the water supply valve.
For NRCR models, close the hot water return valve.

(For EZ models)

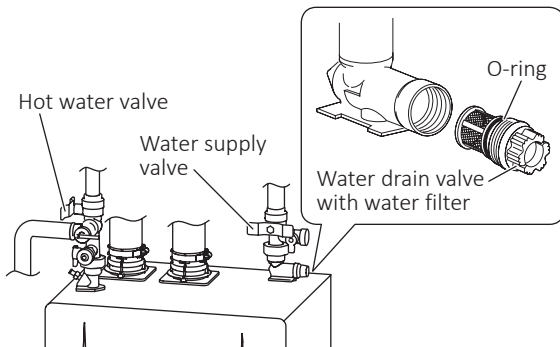

(For NRCR models)

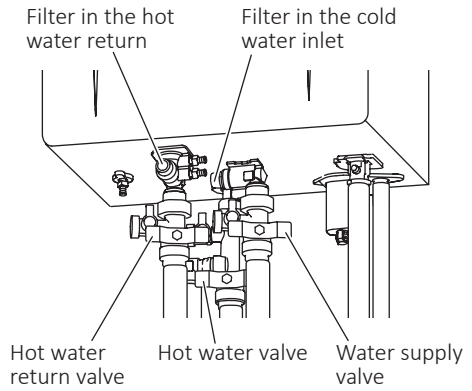
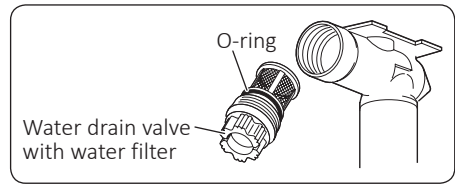

2. With a bucket ready, remove the water drain valve.

NOTE Depending on the model, up to 0.74 gallons (2.8 L) of water may drain out.

3. Clean the water filter with a brush under running water.
4. Reattach the water drain valve (with water filter).

NOTE Do not lose the o-ring.

5. Open the hot water valve and the water supply valve.
For NRCR models, open the hot water return valve.
Make sure water does not leak from the water drain valve.

Water Quality and Maintenance

- For people who live in a hard water area, periodic flushing is necessary. If the heat exchanger is not flushed, the scale build-up may cause damage to the heat exchanger.

To prevent damage to the heat exchanger, the heat exchanger regularly needs to be flushed.

- This water heater is equipped with an automatic descaling reminder to announce for flushing the heat exchanger.

The factory default of this descaling reminder is disable.

If desired, the customer or installer needs to enable the descaling reminder.

Refer to the “Water Treatment: About the Descaling Reminder Function” in the installation manual.

- If the descaling reminder is selected to ON, the code “C1#” (#=1,2,3,4 ... 9) will displayed on the operation panel after the set time period has been reached. When the code is displayed, the heat exchanger needs to be flushed to prevent damage from scale build-up. Refer to the “Procedure for Flushing the Heat Exchanger” in the installation manual or contact Noritz America for more information. (<http://support.noritz.com/> or 1-866-766-7489)
- Damage to the water heater as a result of below is not covered by the Noritz America Limited Warranty. To ensure full warranty coverage, treat or condition water that exceeds the target levels provided in this table.
 - Water in excess of 12 gpg (200 mg/L) of hardness
 - Poor water quality (see the following table)
 - The water heater has displayed a “C1#” (descaling reminder) indicating scale build-up, but the heat exchanger has not been flushed.

Contaminant	Maximum Allowable Level
Total Hardness*	200 mg/L (12 gpg) or less
Aluminum	0.05 to 0.2 mg/L or less
Chloride	250 mg/L or less
Copper	1.0 mg/L or less
Iron	0.3 mg/L or less
Manganese	0.05 mg/L or less
pH	6.5-8.5
Total Dissolved Solids	500 mg/L or less
Zinc	5 mg/L or less
Sulfate	250 mg/L or less
Residual chlorine*	4 mg/L or less

Source: EPA National Secondary Drinking Water Regulations (40 CFR Part 143.3)

* Maximum limit suggested by Noritz.

Troubleshooting

Initial Operation

The water heater does not attempt to ignite when water is running.

- Check for reversed plumbing or crossed pipes.
- Check the water filter. (See page 27)

The water heater attempts to ignite but fails.

- Reset the water heater and try again. There may be air in the gas line.
- Have a professional check the gas supply pressure.

Operation Panel

The surface of the operation panel on the water heater has torn, peeled, or air bubbles inside.

- The surface of the operation panel is affixed with a protective sheet (to prevent surface scratching, etc.) at time of shipment. This sheet can be removed or left as it is.

If you forgot your lock screen password.

- Press and hold the OK button for 5 seconds to unlock while “Input Password” is displayed.

EZ Start Plus app

When the app starts, “New version is available.” is displayed.

- App update is required. Tap “OK” to update the app from the store.

When the app starts, “Firmware update required.” is displayed.

- The Bluetooth firmware in the water heater is required to update. Tap “UPDATE” and wait for a while until updated is complete.

App cannot connect.

- Is Bluetooth of your smartphone turned on?
- Is your smartphone too far away from the water heater?
- Is another smartphone already connected?
- After closing the app, wait at least 30 seconds before reconnecting.

Recirculation does not start at the scheduled time.**It starts at outside of the scheduled time.**

- The clock inside the unit is corrected to the time on your smartphone when the unit is connected to the app. The time on the clock inside the unit may not be correct after a power outage or when the unit has not been connected to the app for a while. Connect to the app and check the recirculation schedule.

Remote Controller

The POWER indicator does not light up.

- Is the power connected properly?

The plastic on the surface or buttons of the remote controller has torn, peeled, or air bubbles inside.

- The surface of the remote controller is affixed with a protective sheet (to prevent surface scratching, etc.) At time of shipment. This sheet can be removed or left as it is. When leaving the protective sheet on, areas frequently touched may tear or peel. However, the remote controller will not malfunction from water entering such torn or peeled areas. To restore the appearance of the remote controller surface, simply remove the protective sheet.

Temperature

Hot water is not available when a fixture is opened.

- Are the gas and water supply valves fully open?
- Is the water supply cut off?
- Is the hot water fixture/faucet sufficiently open?
- Is the gas being cut off by the gas meter? (Can other gas devices such as stoves be used?)
- (For Propane (LP) gas) Is there enough gas in the tank? (Can other gas devices such as stoves be used?)
- Is the water filter clogged? (See page 27)
- Is the POWER button / Power switch turned on?

No water is available when a fixture is opened.

- Is the water supply cut off?
- Is the water heater frozen?

The hot water is not the correct temperature.

- Is the hot water fixture/faucet sufficiently open?

Water takes time to become hot when turning the hot water fixture/faucet.

- Have you allowed enough time for the cold water in the pipes to drain out?

The water is too hot.

- Are the gas and water supply valves fully open?
- Is the water temperature setting appropriate? (See page 13)
- If the water supply temperature is high, it is possible for the temperature to be higher than the temperature set on the operation panel, app, or remote controller.
- If only a small amount of hot water is demanded, it is possible for the temperature to be higher than the temperature set on the operation panel, app, or remote controller.

The water is not hot enough.

- Are the gas and water supply valves fully open?
- Is the water temperature setting appropriate? (See page 13)
- If the amount of hot water required is very high, it is possible for the temperature to be lower than the temperature set on the operation panel, app, or remote controller. Decrease the amount of hot water passing through the water heater and the temperature should stabilize.

The water is cold when only a single fixture is open.

- The unit will not heat the water if the flow rate is less than 0.26 GPM (1.0 L/min)*. Open the fixture more or open other fixtures so that a greater flow passes through the unit, and the unit should begin heating again.
*Minimum activation flow rate: 0.4 GPM (1.5 L/min)
Minimum operating flow rate: 0.26 GPM (1.0 L/min)

Fluctuations in hot water temperatures.

- Set water temperature at 115°F to 120°F (in °F mode) / 48°C to 50°C (in °C mode). This will allow you to use a higher flow of hot water thus meeting the minimum flow requirement of 0.26 GPM (1.0 L/min)*.
*Minimum activation flow rate: 0.4 GPM (1.5 L/min)
Minimum operating flow rate: 0.26 GPM (1.0 L/min)
- Clean the water filter of any debris. (See page 27)

Setting temperature cannot rise.

- Is the maximum temperature setting appropriate? (See page 12, 16, or 21)

Amount of Hot Water

The amount of hot water in the tub is less/more than the set amount.

- When hot water is used for other fixtures while filling the tub, the tub will not fill as much.
- If there is water in the tub already, or when filling is stopped and restarted, the tub will fill more.

The flow meter alarm does not sound even when filled to the set amount.

- The flow meter alarm is set to sound when hot water is continuously discharged for the set volume of water.
If mixing valves are used, or if cold water is mixed with hot water at the fixture, the tub will fill more than the setting of the flow meter alarm.

The amount of hot water at a certain fixture is not constant.

- When hot water is demanded at other fixtures, the amount available may be reduced.
Refer to “Maximum Hot Water Capacity” in “Specifications” for the maximum flow rate. (See page 34)
- Pressure fluctuations and other plumbing conditions can cause the temperature and pressure at a fixture to be unstable, but it should stabilize after a short time.
- There are some types of hot water taps that discharges large volumes of hot water at first but stabilize after time.
- To keep the temperature stable, the water heater limits the amount of water that can flow through it to a small amount initially, but the amount increases over time.

Amount of hot water available has decreased over time.

- Is the water filter clogged? (See page 27)
- If the supply water is hard and has not been treated, scale can build-up in the water heater and decrease the maximum amount of hot water available. Scale can be removed from the water heater by flushing the water heater periodically. To prevent scale from forming in the water heater, a water softener or scale inhibitor is recommended.

Hot Water Delivery (NRCR models only)

Hot water is taking too long.

- (“Auto Learning” is selected in “Recirculation Mode”) The water heater automatically learns based on water usage patterns. It may take several days to properly adjust to your schedule. Usage pattern may have also been reset if the water heater has not been utilized. (Refer to page 15 for more details)

No recirculation activation.

- When using this water heater in on-demand mode, the auto-recirculation feature does not meet the requirements for this standard. To use the recirculation mode according to Title 24 standard, push the on-demand switch to manually operate the recirculation pump.

Recirculation operates with only cold water is being used.

- Check to see if the crossover valve is installed. The crossover valve utilizes the cold water line as a return, allowing the system to function similar to a dedicated return line. The water heater will operate and learn the hot water usage.

Sounds

The fan can be heard after operation is stopped. A motor can be heard when turning the water heater on or off, when opening or closing a fixture, or after the water heater has been running for a while.

- These noises indicate the proper operation of devices which are designed to let the water heater reignite more quickly, and ensure the water temperature is stable.

(NRCR models only)

The water heater makes noise when there is no hot water being used.

- The water heater operates automatically to recirculate water, prevent freezing or prevent stagnant water. It is not abnormal.

Other

The water heater stops burning during operation.

- Are the gas and water supply valves fully open?
- Is the water supply cut off?
- Is the hot water fixture/faucet sufficiently open?
- Is the gas being cut off by the gas meter? (Can other gas devices such as stoves be used?)
- (For Propane (LP) gas) Is there enough gas in the tank? (Can other gas devices such as stoves be used?)

White smoke comes out of the exhaust vent on a cold day.

- This is normal. The white smoke is actually steam.

The hot water is turbid.

- This is harmless. Small bubbles appear as the air in the water is heated and depressurized rapidly to atmospheric pressure.

The water appears blue.

The tub/wash-basin has turned blue.

- Coloration to a blue color may be noticed from small traces of copper ion contained in the water and fat (furring). However, there are not problems concerning health. Coloration of the tub/wash-basin can be prevented by cleaning frequently.

Frequent water discharge from the condensate drain pipe.

- Condensation forms inside the water heater during operation and is discharged from the condensate drain pipe.

Exhaust gas has an odor and burns my eyes.

- Gas conversion may not have been performed correctly.
When you use Propane (LP) gas, check to see if the gas conversion sticker is attached to the unit. If the sticker is not attached, do not use the unit and contact the installer.

Checking for Error Conditions

When a failure occurs, information relating to the error blinks on the operation panel and remote controller.

If this occurs, take appropriate measures as the following list.

Error Code : 06, 061, 062 (NRCR models only)

Cause : Recirculation abnormality

Action : • Check return line filter.

- Check the crossover valve's filter.
- Contact Noritz America if there are any other questions.

Error Code : 11

Cause : Ignition failure

Action : Check whether the gas valve is open. The water heater resumes operation when the hot water fixture is closed and then opened. (The error can also be cleared by turning the POWER button / Power switch off and then on.) If the blinking number doesn't return the problem is solved.

Error Code : 90, 901, 902

Cause : [When supplying combustion air from the indoors]

The air supply vent may be clogged.

Action : Check air supply vent for blockage or obstruction. (See page 26)

Cause : Exhaust vent may be clogged.

Action : Check exhaust vent for blockage or obstruction.

Cause : Abnormal combustion, low gas supply pressure.

Action : Have a professional check the gas supply pressure.

Cause : Condensate drain line may be clogged.

Action : Check condensate drain line is clogged or frozen. If the display continues, contact nearest Noritz agent.

Error Code : 91

Cause : Gas conversion has not been performed correctly.

Action : Contact the installer.

Error Code : C1# (# = 1-9)

Cause : Descaling Reminder (Notice for periodic maintenance)

Action : This water heater is equipped with an automatic descaling reminder. Excessive scale build-up may cause premature failure of the heat exchanger. Excessive dust or lint build-up in the fan and air intake may affect efficiency and combustion performance. Contact Noritz America for additional information about recommended maintenance procedures (1-866-766-7489).

Contact Noritz America if:

- Any other error code appears.
- An error code is indicated again after the above actions were followed.
- There are any other questions.

Follow-up Service

Requesting Service

First follow the instructions in the troubleshooting section. (See page 28)
If the error is not corrected, contact Noritz America Technical Support at 1-866-766-7489.

We will need to know:

- **The Model**
- **Serial number**
- **Gas type**

Check the rating plate (see page 4 for the location of the label) or "Heater Info." (see page 20).

- **Date of purchase**
- **Details of problem**
Blinking error codes, etc., in much detail as possible
- **Your name, address, and telephone number**
- **Desired date of visit**

NOTE A request for service may be rejected if the water heater is installed in a location where working on the water heater may be dangerous. Contact a plumber.

Warranty

The warranty registration information is shown on page 36 of this owner's guide. Be sure that installer name, date of purchase and other necessary information are filled in when registering your product.

Read the content carefully, and keep this owner's guide in a safe place.

For repairs after the warranty period, there will be a charge on any service, and service will only be performed if the unit is deemed repairable.

Period of Time for Stocking Repair Parts

Noritz will stock repair and maintenance parts for this model for 10 years (12 years for the heat exchanger) after production of this model has ended.

Re-installation

If you want to reinstall the unit at a different location, confirm that the gas and power supply indicated on the rating plate are available at the new location. If you are not sure, consult the local utility company.

Gas Conversion

- The factory setting for the gas type of this unit is Natural gas (NG). When the supplied gas is Propane (LP), gas conversion procedures including gas orifice replacement must be performed during installation using the Propane (LP) gas conversion kit (supplied part). (Units for which the conversion has been performed have a gas conversion sticker attached)
- If you move to a region that uses a different type of gas or if the local gas supply is converted, replacement of the gas orifice and adjustment of the unit will be necessary.
- This work must be performed by Noritz or a qualified installer, service agency, or the gas supplier and will be charged for even during the warranty period. The qualified installer will also be responsible for purchasing the gas conversion kit directly from the manufacturer.
- For more information, contact Noritz America Technical Support at 1-866-766-7489.

⚠ WARNING





- Do not use the Propane (LP) gas conversion kit (supplied part) that you did not use during installation or the Natural gas (NG) orifice that was replaced during installation for other units.
- The gas conversion kit shall be installed by a qualified installer, service agency*, or the gas supplier in accordance with the manufacturer's instructions and all applicable codes and requirements of the authority having jurisdiction.
- The information in the instructions must be followed to minimize the risk of fire or explosion or to prevent property damage, personal injury, or loss of life.
- The qualified installer, service agency, or the gas supplier is responsible for the proper installation of this kit.
- The installation is not proper and complete until the operation of the converted unit is checked as specified in the manufacturer's instructions supplied with the kit.

* A qualified installer or service agency is any individual, firm, corporation, or company which either in person or through a representative is engaged in and is responsible for the connection, utilization, repair or servicing of gas utilization equipment or accessories; who is experienced in such work, familiar with all precautions required, and has complied with all of the requirements of the authority having jurisdiction.

1. Before the gas conversion is performed, verify the proper gas conversion kit with your water heater model on the table provided below.

Conversion Kit	Conversion Type
CK-84	Propane to Natural Gas
CK-85	Natural Gas to Propane

2. The following parts are supplied in the conversion kit. These items will replace the existing parts that are currently installed in the water heater.

Orifice 	O-rings 	Gas Conversion Sticker 	Gasket (for Emission monitoring port cap) 
Gas Conversion Connector  This connector is including in only CK-85 to convert from Natural Gas to Propane.			

- NOTE**
- Make sure that all parts are replaced and properly installed by a qualified installer, service agency.
 - A digital gas manometer and a gas analyzer are required to complete the installation. Do not proceed if the equipment is not immediately available.

3. After the necessary parts have been replaced on the water heater, gas conversion must be completed by using the app or the operation panel.
4. The following pressure value are verified by the installer.
 - The inlet gas pressure value at the gas supply inlet fitting
 - The offset pressure value at the gas valve
5. Proper adjustments will be made to ensure safe and efficient operation.
6. Once this is completed, a final gas leak check will be performed to confirm that all parts have been securely installed.

- NOTE** If you notice the smell of gas at any time after the installation has been completed, turn the water heater off and contact your gas supplier immediately.

Specifications

- Specifications may be changed without prior notice.
- The capacity may differ slightly, depending on the water pressure, water supply, piping conditions, and water temperature.

Item		Specification		
Model Name		EZ111DV (GQ-C3261WX-FF-1 US)	EZ98DV (GQ-C2861WX-FF-1 US)	EZ71DV (GQ-C2661WX-FF-1 US)
Type	Installation	Indoor / Outdoor Wall mounted		
	Air Supply / Exhaust	Power Vented		
Ignition		Direct Ignition		
Operating Pressure		15-150 psi (Recommended 50 to 80 psi for maximum performance)		
Minimum Activation Flow Rate*		0.4 GPM (1.5 L/min)		
Minimum Operating Flow Rate*		0.26 GPM (1.0 L/min)		
Dimensions (Height) × (Width) × (Depth)		26.1 in. (662 mm) × 18.1 in. (461 mm) × 11.8 in. (300 mm)		
Weight		62 lbs. (28 kg)		
Water Holding Capacity		0.74 gal (2.8 L)		
Connection Sizes	Water Inlet	NPT 3/4 in.		
	Hot Water Outlet	NPT 3/4 in.		
	Gas Inlet	NPT 3/4 in.		
	Condensate Drain	NPT 1/2 in.		
Power Supply	Supply	120 VAC (60 Hz)		
	Consumption (NG / Propane (LP))	105 W / 108 W	81 W / 83 W	62 W / 65 W
		Freeze Prevention	114 W	
	Maximum Current	4 Amps		
Gas Consumption	Maximum	199,900 Btu/h	180,000 Btu/h	160,000 Btu/h
	Minimum	12,800 Btu/h		
Maximum Hot Water Capacity (45°F (25°C) Rise)		8.7 GPM (33 L/min)	7.6 GPM (29 L/min)	6.9 GPM (26 L/min)
Capacity Range		0.4-11.1 GPM (1.5-42 L/min)	0.4-9.8 GPM (1.5-37 L/min)	0.4-9.0 GPM (1.5-34 L/min)
Temperature Settings	°F Mode	100-140°F (in 5°F intervals) (9 options)		
	°C Mode	37-48°C (in 1°C intervals), 50-60°C (in 5°C intervals) (15 options)		
Materials	Casing	Front Cover, Side/Top Plate: Hot-dipped zinc-aluminum-magnesium-alloy-coated steel with Polyester Coating Back, Bottom Plate: Hot-dipped zinc-aluminum-magnesium-alloy-coated steel without Coating		
	Flue Collar	Polypropylene		
	Primary Heat Exchanger	Stainless Steel Sheetting, Stainless Steel Tubing		
	Secondary Heat Exchanger	Stainless Steel Sheetting, Stainless Steel Tubing		
Safety Devices		Flame Rod, High Limit Switch, Lightning Protection Device (ZNR), Freezing Prevention Device, Fan Rotation Detector, Thermal Fuse		
Included Accessories		Anchoring Screws, Wall Mounting Bracket, LP Gas Conversion Kit		

* Minimum flow rate may change by setting temperature and water temperature.

Item		Specification	
Model Name		NRCR111DV (GQ-C3261WXQ-FF-1 US)	NRCR92DV (GQ-C2661WXQ-FF-1 US)
Type	Installation	Indoor / Outdoor Wall mounted	
	Air Supply / Exhaust	Power Vented	
Ignition		Direct Ignition	
Operating Pressure		15-150 psi (Recommended 50 to 80 psi for maximum performance)	
Minimum Activation Flow Rate*		0.4 GPM (1.5 L/min)	
Minimum Operating Flow Rate*		0.26 GPM (1.0 L/min)	
Dimensions (Height) × (Width) × (Depth)		26.1 in. (662 mm) × 18.1 in. (461 mm) × 11.8 in. (300 mm)	
Weight		64 lbs. (29 kg)	
Water Holding Capacity		0.74 gal (2.8 L)	
Connection Sizes	Water Inlet	NPT 3/4 in.	
	Hot Water Outlet	NPT 3/4 in.	
	Hot Water Return	NPT 3/4 in.	
	Gas Inlet	NPT 3/4 in.	
	Condensate Drain	NPT 1/2 in.	
Power Supply	Supply	120 VAC (60 Hz)	
	Consumption (NG / Propane (LP))	157 W / 160 W	119 W / 122 W
	Freeze Prevention	114 W	
	Maximum Current	4 Amps	
Gas Consumption	Maximum	199,900 Btu/h	165,000 Btu/h
	Minimum	12,800 Btu/h	
Maximum Hot Water Capacity (45°F (25°C) Rise)		8.7 GPM (33 L/min)	7.1 GPM (27 L/min)
Capacity Range		0.4-11.1 GPM (1.5-42 L/min)	0.4-9.2 GPM (1.5-35 L/min)
Temperature Settings	°F Mode	100-140°F (in 5°F intervals) (9 options)	
	°C Mode	37-48°C (in 1°C intervals), 50-60°C (in 5°C intervals) (15 options)	
Materials	Casing	Front Cover, Side/Top Plate: Hot-dipped zinc-aluminum-magnesium-alloy-coated steel with Polyester Coating Back, Bottom Plate: Hot-dipped zinc-aluminum-magnesium-alloy-coated steel without Coating	
	Flue Collar	Polypropylene	
	Primary Heat Exchanger	Stainless Steel Sheeting, Stainless Steel Tubing	
	Secondary Heat Exchanger	Stainless Steel Sheeting, Stainless Steel Tubing	
Safety Devices		Flame Rod, High Limit Switch, Lightning Protection Device (ZNR), Freezing Prevention Device, Fan Rotation Detector, Thermal Fuse	
Included Accessories		Anchoring Screws, Wall Mounting Bracket, LP Gas Conversion Kit	

* Minimum flow rate may change by setting temperature and water temperature.

Noritz America Corporation LIMITED WARRANTY - TANKLESS WATER HEATERS

1. What is Covered by this Warranty During the applicable Warranty Period (specified below), Noritz America Corporation (“Noritz”) warrants to the original purchaser (“Buyer”) that the new Noritz gas water heater in the originally installed location (“Product”) is free from material defects in material or workmanship (the “Warranty”). There are different Warranty Periods for different components of the Product, as described below. This Warranty is for the benefit of the original Buyer only and terminates upon transfer of the Product from the original Buyer to any other person or entity. For this Warranty to be effective (i) the Product must be installed by a method recognized and authorized by Noritz and in compliance with Noritz published materials specifically indicated in writing to be applicable to the type and model number of the Product and in compliance with instructions in the Installation Manual and Owner’s Guide, which are included with the Product (“Proper Installation”); and (ii) Buyer must use the Product in compliance with instructions in the Installation Manual and Owner’s Guide, which are included with the Product.

2. Warranty Period This Warranty is provided by Noritz to the Buyer for the duration of the applicable Warranty Period for the particular component of the Product as specified below. This Warranty takes effect (“Warranty Effective Date”) on the date of Proper Installation of the Product, or 30 days after the date of purchase of the Product, whichever occurs first, and is effective until the expiration of the “Warranty Period” for the particular Product component as shown below. The date of Proper Installation must be provided to Noritz as well as a copy of the original receipt for the purchase of the Product to establish the Warranty Effective Date. For example, when the Product is installed in new single-family residential construction, the Warranty Effective Date is the date upon which the Buyer takes title to the real property (e.g., the date of recordation of the deed conveying title to Buyer).

■ Warranty Period for Heat Exchanger

Product	Conditions		
	A) Used in a single family dwelling	B) Used in conjunction with a controlled recirculation system ¹ installed in accordance with the installation manual in a single family dwelling	C) Used in a commercial capacity; used in other than a single family dwelling; supplied with pre-heated water or used in conjunction with uncontrolled recirculation
EZ71, EZ98, EZ111, EZTR50 and EZTR75 (excluding EZTR40)	25 years ²	15 years ³	8 years ⁴
NRCR92 and NRCR111	15 years ³		8 years ⁴
Residential Products with prefix “NR” and 180,000 btu or higher	12 years	12 years ⁵	3 years ⁶
Residential Products with prefix “NR” and 157,000 btu or lower, and EZTR40	12 years	3 years ⁶	
NCC199CDV	25 years ^{2, 7}	15 years ^{3, 7}	10 years ⁸
Commercial Products with prefix “NC” except NCC199CDV	12 years ⁷	12 years ^{5, 7}	5 years ⁹

■ Warranty Period for Parts and Labor

All Products	Parts other than Heat Exchanger	5 years
	Reasonable labor ¹⁰	1 year

Notes:

1. An aquastat is the minimum pump control requirement in order to maintain the full recirculation warranty. Point of use or “on demand” recirculation systems that are thermally controlled (i.e. aquastat) also classify as controlled systems.
2. 25 years or 15,000 operational (burn) hours, whichever occurs first.
3. 15 years or 12,000 operational (burn) hours, whichever occurs first.
4. 8 years or 12,500 operational (burn) hours, whichever occurs first.
5. 12 years or 6,500 operational (burn) hours, whichever occurs first.
6. 3 years or 4,000 operational (burn) hours, whichever occurs first.
7. Provided that temperature is ≤140°F. If temperature is >140°F, then applicable Warranty Period is the one used for a commercial capacity (Condition C above).
8. 10 years or 12,500 operational (burn) hours, whichever occurs first.
9. 5 years or 6,500 operational (burn) hours, whichever occurs first.
10. A reasonable labor rate will be paid by Noritz to service/repair professional on Noritz-approved Warranty repairs, subject to Noritz’s schedule of approved labor allowances.

3. How Do I Use This Warranty? If Buyer discovers, within the applicable Warranty Period, a defect in material or workmanship (“Defect”), Buyer must promptly notify Noritz or its authorized representative. Please notify Noritz by contacting Noritz’s Customer Care at info@noritz.com, or by writing to Noritz Customer Care at 11160 Grace Avenue, Fountain Valley, CA 92708, or by calling Noritz Customer Care at 866-766-7489. Buyer must provide evidence of the Warranty Effective Date (See Section 2 above). Within a reasonable time after Noritz receives such notification, Noritz will ship, at Noritz’s expense, either new or used/refurbished replacement parts to correct a Noritz-confirmed Defect. Buyer is responsible for any other costs, including but not limited to labor for servicing or replacing the part or Product (except to the extent that labor is covered as described in the Warranty Period section above), costs for permits or materials necessary for the repair or replacement, or incidental costs resulting from damage external to the Product resulting from the Defect. The replacement component or Product will be warranted only for the unexpired portion of the original component’s applicable Warranty Period. If during the applicable Warranty Period, the Noritz-provided new or used replacement parts, when properly installed, do not correct the Defect, or if Noritz is unable to correct the Defect after a reasonable number of attempts, Noritz will provide, at its option, one of the following: (i) a replacement new or used/refurbished Product (at Noritz’s option, either the same, comparable or better model), to be shipped at Noritz’s expense, or (ii) a full refund of the purchase price paid for the Product (excluding labor or installation costs). These remedies are the Buyer’s only remedies for breach of Warranty.

4. What is Not Covered by this Warranty Please refer to the Installation Manual and Owner's Guide supplied with your new Noritz Product. In addition, this Warranty becomes null and void if any of the following are determined to be contributing factors to failure of the Product under this Warranty:

- Abuse, neglect, misuse or misapplication
- Improper, dangerous, or destructive maintenance procedures
- Use in conjunction with any unapproved device
- Installation in an environment that is corrosive or otherwise destructive to the Product, whether internal or external
- Incorrect gas or water pressure
- Incorrect sizing for the application
- Use with improper gas type
- Damage as a result of freezing within the Product or surrounding piping
- Damage as a result of use with non-potable water, untreated or poorly treated well water, or water with high pH levels or hardness levels in excess of 12 grains per gallon (200 mg/L). (Please refer to the "Water Quality" section of the Owner's Guide for details)
- Damage caused by acts of God including, but not limited to, fire, flood, lightning, or natural disaster
- Damage caused by use of the Product for purposes other than those for which it was designed
- Damage caused by unauthorized attachments or modifications
- Damage resulting from improper installation of the Product
- Damage during shipment

Product purchased from any seller or retailer that is not authorized by Noritz, or any installer that obtained the Product from a distributor or supplier that is not authorized by Noritz (collectively, "Non-Authorized Product") is not covered by this Warranty and the Warranty shall be void as to such Non-Authorized Product.

5. DISCLAIMER OF WARRANTIES THE FOREGOING WARRANTIES ARE IN LIEU OF ALL OTHER WARRANTIES, EXPRESS OR IMPLIED, INCLUDING BUT NOT LIMITED TO THE IMPLIED WARRANTIES OF MERCHANTABILITY, FITNESS FOR A PARTICULAR PURPOSE OR NON-INFRINGEMENT. NORITZ DISCLAIMS ALL OTHER OBLIGATIONS OR LIABILITIES ON ITS PART AND NEITHER ASSUMES NOR AUTHORIZES ANY OTHER PERSON OR ENTITY TO BIND OR ASSUME FOR NORITZ ANY OTHER LIABILITIES IN CONNECTION WITH THE PERFORMANCE OF THE PRODUCT. THIS WARRANTY ONLY COVERS REPLACEMENT PRODUCT OR PARTS THEREOF, AND EXCEPT AS EXPRESSLY SET FORTH ABOVE, DOES NOT COVER THE COST OF LABOR OR SERVICES UNDER ANY CIRCUMSTANCES. SOME STATES OR PROVINCES DO NOT ALLOW LIMITATIONS ON HOW LONG AN IMPLIED WARRANTY LASTS, SO THE ABOVE LIMITATIONS MAY NOT APPLY TO YOU.

6. LIMITATION OF REMEDIES NORITZ'S TOTAL LIABILITY FOR ANY CLAIM ARISING HEREUNDER SHALL NOT EXCEED THE PURCHASE PRICE WHICH YOU PAID FOR THE PRODUCT. IN NO EVENT WILL NORITZ BE LIABLE FOR ANY SPECIAL, INCIDENTAL, OR CONSEQUENTIAL DAMAGES BASED ON BREACH OF WARRANTY, BREACH OF CONTRACT, NEGLIGENCE, STRICT TORT, OR ANY OTHER LEGAL THEORY. DAMAGES THAT NORITZ WILL NOT BE RESPONSIBLE FOR INCLUDE, BUT ARE NOT LIMITED TO: LOSS OF PROFITS; LOSS OF SAVINGS OR REVENUE; LOSS OF USE OF THE PRODUCT OR ANY ASSOCIATED EQUIPMENT; COST OF CAPITAL; COST OF ANY SUBSTITUTE EQUIPMENT, FACILITIES, OR SERVICES; DOWNTIME; THE CLAIMS OF THIRD PARTIES, INCLUDING CUSTOMERS; AND INJURY TO PROPERTY.

7. Time Limit for Bringing Suit Any action for breach of Warranty must be filed and served within six (6) months following the expiration of the applicable Warranty Period with respect to the particular Product component.

8. No Other Warranties There are no express warranties other than those contained in this agreement. Unless modified in a writing signed by both parties, this agreement is understood to be the complete and exclusive agreement between the parties, superseding all oral or written prior agreements and all other communications between the parties relating to the subject matter of this agreement, including but not limited to statements made by salespersons. No employee or representative of Noritz, or any other person or entity, is authorized to make any warranty in addition to those made in this agreement, or to modify any warranty made in this agreement. Buyer is warned, therefore, to check this agreement carefully to see that it correctly reflects those terms that are important to the Buyer.

9. Allocation of Risks This agreement allocates the risks of Product failure between Noritz and the Buyer. This allocation is recognized by both parties and is reflected in the price of the goods. Buyer acknowledges that it has read this agreement, understands it, and is bound by its terms. This Warranty gives you specific legal rights, and you may also have other rights which vary from state to state or province to province.

Warranty Registration

Register your Noritz product(s) online at www.noritz.com/warranty or by calling Noritz Customer Care at 866-766-7489.

Register your Warranty online at www.noritz.com/warranty



NORITZ AMERICA CORP.
11160 Grace Avenue
Fountain Valley, CA 92708
Phone: (714) 433-2905

This page is intentionally left blank.

This page is intentionally left blank.

